

SOT-23 Plastic-Encapsulate Transistors

BC807^{*} TRANSISTOR (PNP)

FEATURE

- Ideally suited for automatic insertion
- Epitaxial planar die construction
- Complementary NPN type available(BC817)

MAXIMUM RATINGS (T_a=25°C unless otherwise noted)

Symbol	Parameter	Value	Unit
V _{CB0}	Collector-Base Voltage	-50	V
V _{CEO}	Collector-Emitter Voltage	-45	V
V _{EBO}	Emitter-Base Voltage	-5	V
I _C	Collector Current	-500	mA
P _C	Collector Power Dissipation	300	mW
R _{θJA}	Thermal Resistance From Junction To Ambient	417	°C/W
T _J	Junction Temperature	150	°C
T _{stg}	Storage Temperature	-55~+150	°C

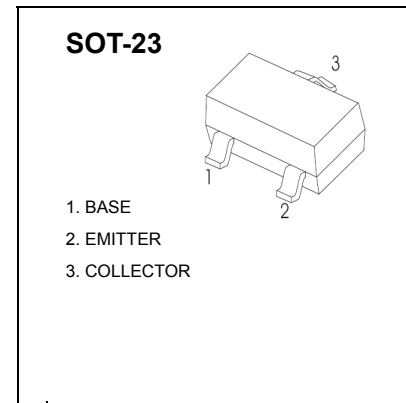

ELECTRICAL CHARACTERISTICS (T_a=25°C unless otherwise specified)

Parameter	Symbol	Test conditions	Min	Max	Unit
Collector-base breakdown voltage	V _{CB0}	I _C = -10μA, I _E =0	-50		V
Collector-emitter breakdown voltage	V _{CEO}	I _C = -10mA, I _B =0	-45		V
Emitter-base breakdown voltage	V _{EBO}	I _E = -1μA, I _C =0	-5		V
Collector cut-off current	I _{CB0}	V _{CB} = -45V, I _E =0		-0.1	μA
Emitter cut-off current	I _{EBO}	V _{EB} = -4 V, I _C =0		-0.1	μA
DC current gain	h _{FE(1)}	V _{CE} = -1V, I _C = -100mA	100	600	
	h _{FE(2)}	V _{CE} = -1V, I _C = -500mA	40		
Collector-emitter saturation voltage	V _{CE(sat)}	I _C =-500mA, I _B = -50mA		-0.7	V
Base-emitter saturation voltage	V _{BE(sat)}	I _C = -500mA, I _B = -50mA		-1.2	V
Transition frequency	f _T	V _{CE} = -5V, I _C = -10mA f=100MHz	100		MHz

CLASSIFICATION OF h_{FE}(1)

Rank	BC807-16	BC807-25	BC807-40
Range	100-250	160-400	250-600
Marking	5A	5B	5C

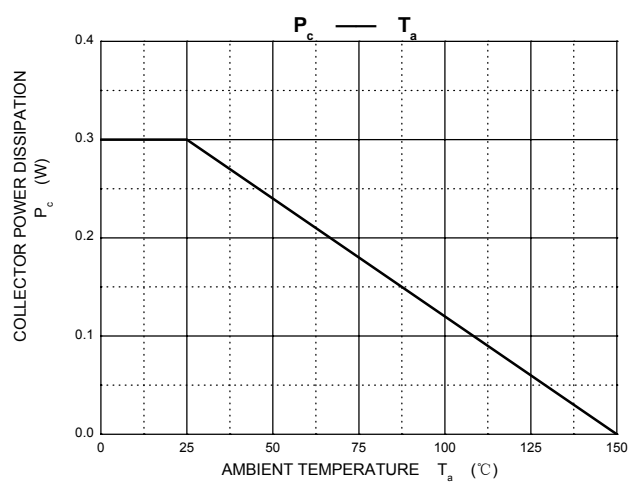
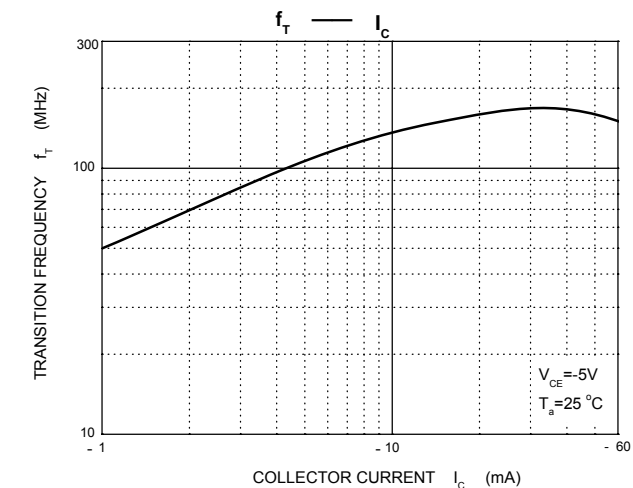
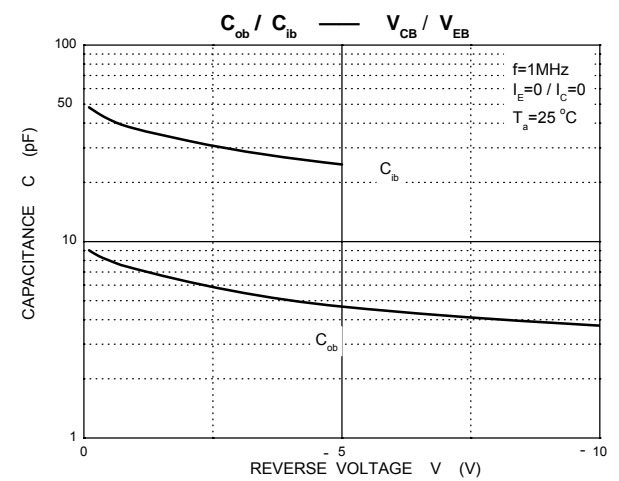
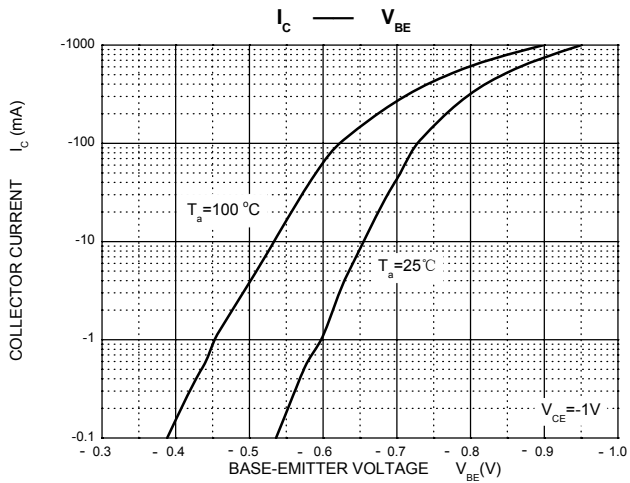
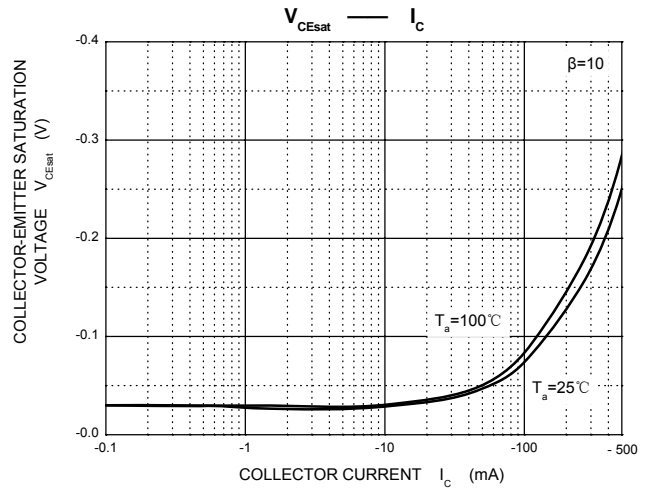
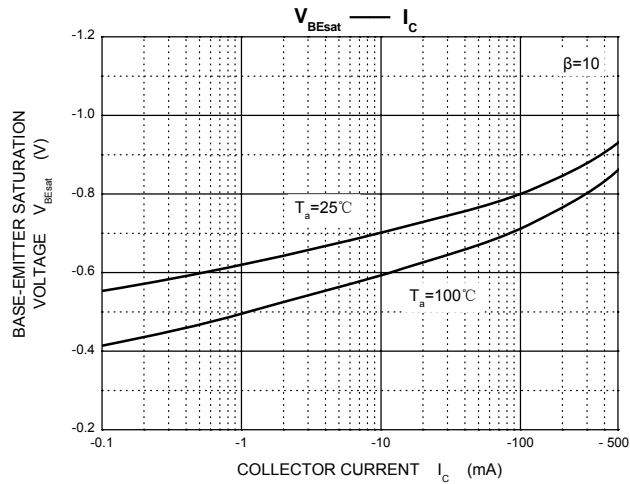
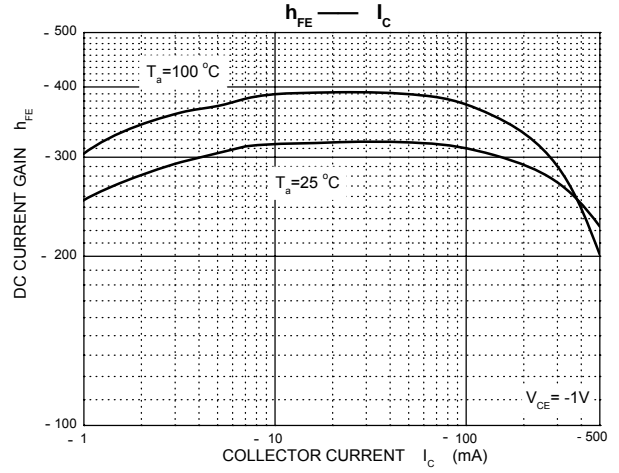
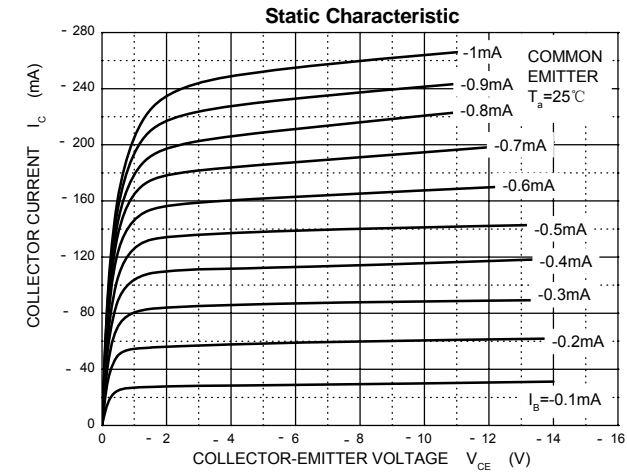
Typical Characteristics



SOT-23 Package Outline Dimensions

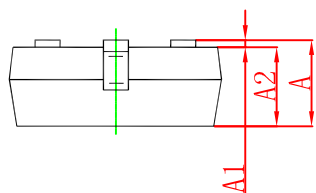
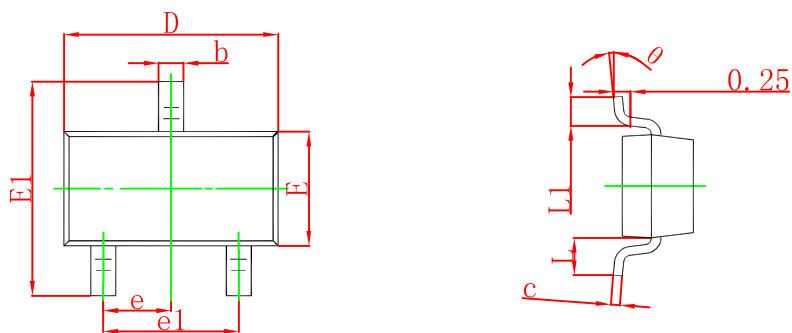

Symbol	Dimensions In Millimeters		Dimensions In Inches	
	Min	Max	Min	Max
A	0.900	1.150	0.035	0.045
A1	0.000	0.100	0.000	0.004
A2	0.900	1.050	0.035	0.041
b	0.300	0.500	0.012	0.020
c	0.080	0.150	0.003	0.006
D	2.800	3.000	0.110	0.118
E	1.200	1.400	0.047	0.055
E1	2.250	2.550	0.089	0.100
e	0.950 TYP		0.037 TYP	
e1	1.800	2.000	0.071	0.079
L	0.550 REF		0.022 REF	
L1	0.300	0.500	0.012	0.020
θ	0°	8°	0°	8°

SOT-23 Suggested Pad Layout

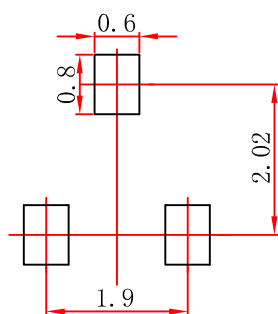

- Note:
1. Controlling dimension: in millimeters.
 2. General tolerance: $\pm 0.05\text{mm}$.
 3. The pad layout is for reference purposes only.

SOT-23 Tape and Reel

SOT-23 Embossed Carrier Tape

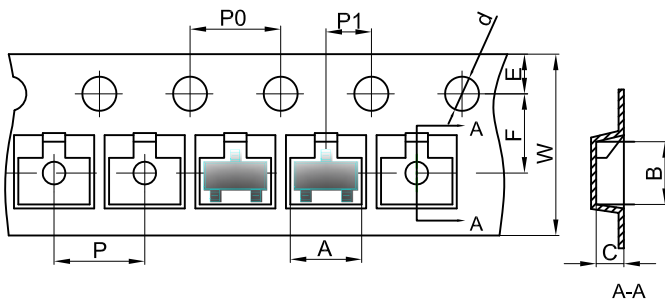

Packaging Description:

SOT-23 parts are shipped in tape. The carrier tape is made from a dissipative (carbon filled) polycarbonate resin. The cover tape is a multilayer film (Heat Activated Adhesive in nature) primarily composed of polyester film, adhesive layer, sealant, and anti-static sprayed agent. These reeled parts in standard option are shipped with 3,000 units per 7" or 17.8cm diameter reel. The reels are clear in color and is made of polystyrene plastic (anti-static coated).

Dimensions are in millimeter

Pkg type	A	B	C	d	E	F	P0	P	P1	W
SOT-23	3.15	2.77	1.22	Ø1.50	1.75	3.50	4.00	4.00	2.00	8.00

SOT-23 Tape Leader and Trailer

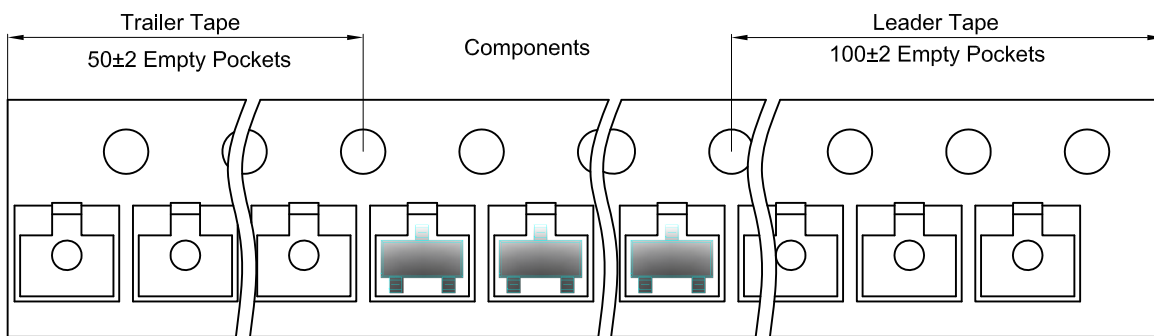

SOT-23 Reel

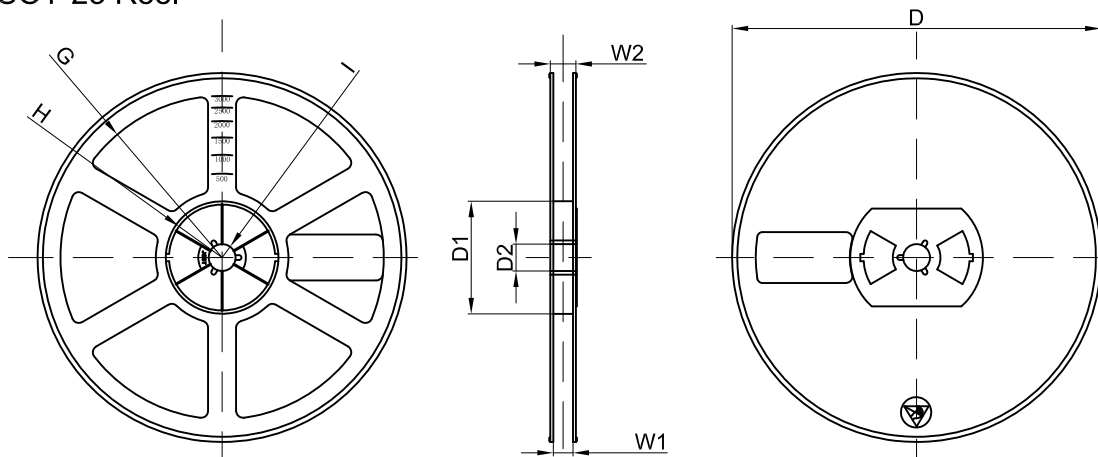

Dimensions are in millimeter

Reel Option	D	D1	D2	G	H	I	W1	W2
7"Dia	Ø178.00	54.40	13.00	R78.00	R25.60	R6.50	9.50	12.30

REEL	Reel Size	Box	Box Size(mm)	Carton	Carton Size(mm)	G.W.(kg)
3000 pcs	7 inch	45,000 pcs	203×203×195	180,000 pcs	438×438×220	